

CRYOGENIC Partak

Techno Market Industries co

- CRYOGENIC RECIPROCATING PUMPS
- CRYOGENIC CENTRIFUGAL PUMPS
- CRYOGENIC GLOBE VALVES
- CRYOGENIC CHECK VALVES
- VAPORIZERS
- CRYOGENIC TANKS
- HIGH PRESSURE NEEDLE VALVES





Partak

Techno Market Industries co

CRYOGENIC RECIPROCATING PUMPS

CRYOFAN™ - PRX Series

LIN . LOX . LAr
CH4 . LNG . LPG



Model	Cylinder Dia.	Stroke	Power	Speed	Capacity	Pressure
	(mm)	(mm)	KW	RPM	Lit/h	Bar
PRX-35-25-200/300	25	35	7.5	1400	300	200
PRX-35-32-200/500	32	35	7.5	1400	500	200
PRX-35-25-200/195	25	35	7.5	900	195	200
PRX-35-32-200/360	32	35	7.5	900	362	200
PRX-35-32-300/500	32	35	11	1400	500	300
PRX-35-25-300/300	25	35	11	1400	300	300
PRX-35-25-500/250	25	35	15	1400	250	500
PRX35-32-500/400	32	35	15	1400	400	500
PRX-35-85-30/4500	85	35	11	1400	4500	30



Partak

Techno Market Industries co

CRYOGENIC RECIPROCATING PUMPS

CRYOFANTM - PRC Series

LCO₂.LN₂O



Model	Piston Dia. (mm)	Capacity (Kg/h)	Pressure (Bar)		Connection size (inch)			Electromotor
			effective	Final	Inlet	Outlet	Return	
PRC-35-32-100/400	32	400	70	100	1	1	1/4	4Kw,1400 rpm,3 phase,50 Hz



Partak

Techno Market Industries co

CRYOGENIC CENTRIFUGAL PUMPS

CRYOFAN™ - PCD Series

DIRECT DRIVEN

- Direct driven pump with a speed of 7000 rpm
- Capacity 400 liters per minute
- Outlet pressure 16 bar
- Transfer type
- Mechanical seal

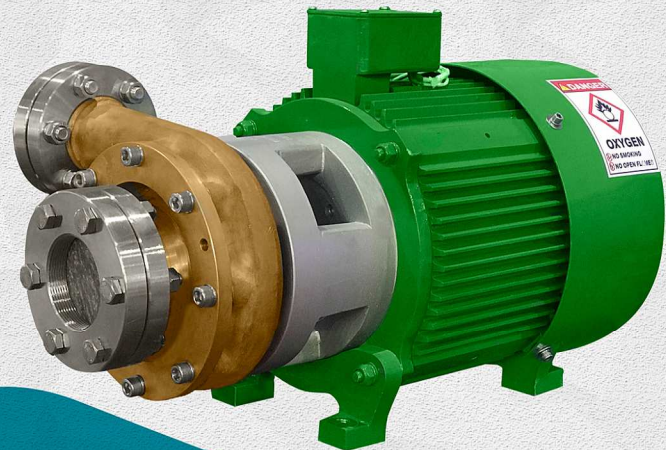

Outlet lit/min	Pressure bar	Power kw	Motor speed rpm	Pump speed rpm	Impeller Dia. mm
200 ~ 600	16	22	6800	6800	155

- Gearless pump with a speed of 3000 rpm (low pressure)
- Capacity 300 liters per minute
- Inlet pressure 0.5 and outlet pressure 5 bar
- Transfer type
- Mechanical seal

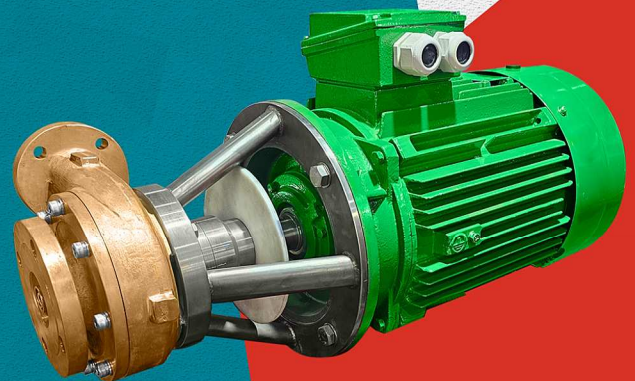

Outlet lit/min	Pressure bar	Power kw	Motor speed rpm	Pump speed rpm	Impeller Dia. mm
170 ~ 300	5	22-18	3000	3000	155



Partak

Techno Market Industries co

CRYOGENIC CENTRIFUGAL PUMPS

CRYOFAN™ - PCG Series

GEARBOX DRIVEN

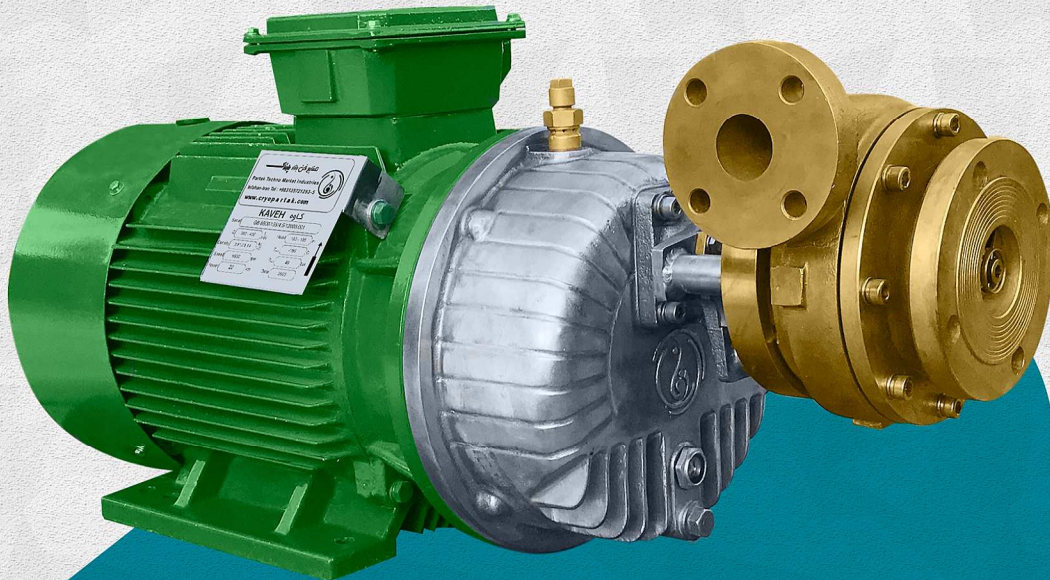

- Gearbox driven pump with a speed of 7000 rpm
- Capacity 400 liters per minute
- outlet pressure 16 bar

Outlet lit/min	Pressure bar	Power kw	Motor speed rpm	Pump speed rpm	Impeller Dia. mm
200 ~ 600	16	22	3000	6800	155



Partak

Techno Market Industries co

CRYOGENIC GLOBE VALVES

CRYOFAN™ -VG180 Series



Features:

- Shaft packing (PTFE)
- Socket welded connection
- Use of anti-explosion grease
- Body and upper part of stainless steel (1.4308.304)
- Degreased and suitable for oxygen service
- Seat (sealing seat) made of carbonized PTFE

Size		Working Pressure(bar)
DN	NPS	PN
15	3/8	40
15	1/2	40
20	3/4	40
25	1	40
40	1.1/2	40
50	2	40
65	2.1/2	40
80	3	40

CRYOGENIC GLOBE VALVES

CRYOFAN™ -VG90 Series





Partak

Techno Market Industries co

CRYOGENIC CHECK VALVES

CRYOFAN™ -VC Series



Name	Number
Body	1
Valve Seat	2
Socket Screw	3
S.t Steel Spring	4
Washer	5
Cap	6
Screw	7

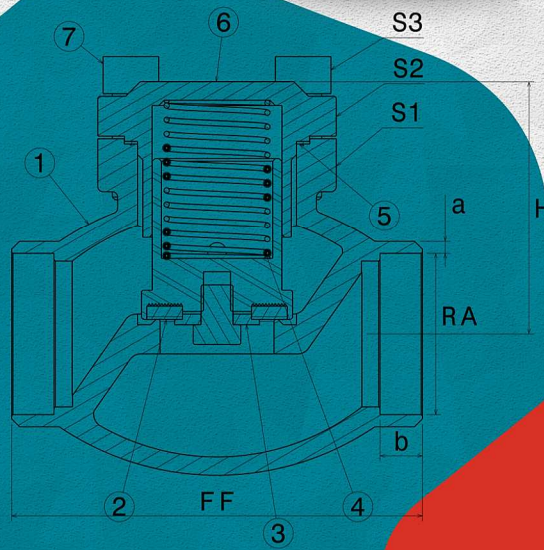

HIGH PRESSURE NEEDLE VALVES

CRYOFAN™ -VN Series

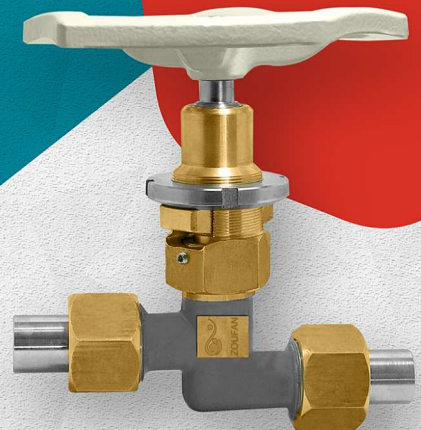



Partak

Techno Market Industries co

CRYOGENIC HEAT TRANSFERS (VAPORIZERS)

CRYOFANTM - HAH Series

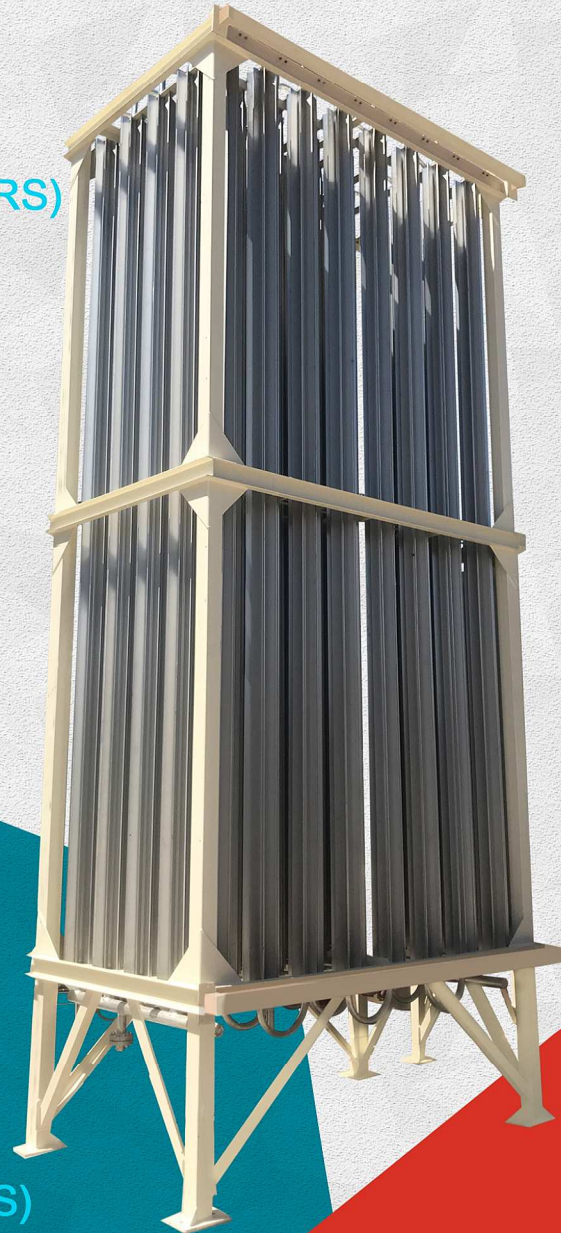

	Max Working Press.(bar)	Test Press.(bar)	Inner Pipe	No.of Fins Aluminum Alloy6063	Height	capacity for each meter of Height (Nm ³ /h)
High.Pressure Vaporizer Type 1	200	300	1/2" Sch40	8	As Per order	3.5
High.Pressure Vaporizer Type 2	300	450	1/2" Sch80	8	As Per order	3.2
LowPressure Vaporizer	40	60	1"Grooved Inside	16	As Per order	5

CRYOGENIC HEAT TRANSFERS (VAPORIZERS)

CRYOFANTM - HAL Series





Partak

Techno Market Industries co

CRYOGENIC TANKS

CRYOFANTM -ZT Series



CRYOGENIC DEWARES

CRYOFANTM -ZD Series





Partak

Techno Market Industries co

CRYOGENIC SKID - MOUNTED

CRYOFANTM -ZS Series

Filling , Purging and Testing Packages

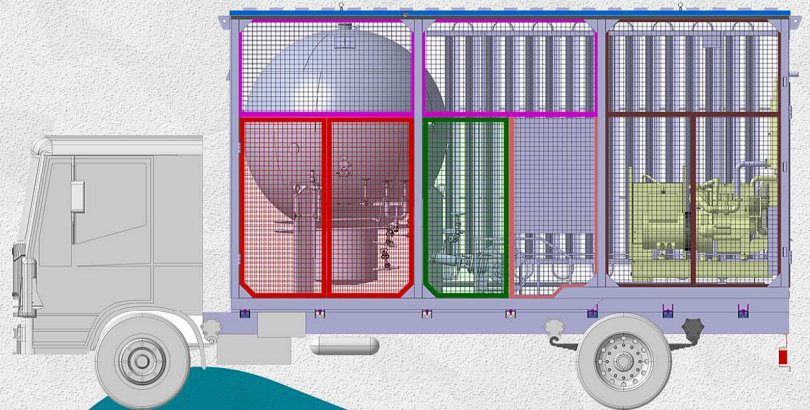



Partak

Techno Market Industries co

No:124 , First Ave , Jey Industrial
State , Esfahan , IRAN

☎ 0 3 1 3 5 7 2 1 2 5 3 - 5

🌐 www.zoufan.com

✉ info@cryopartak.com